

REVIEW ARTICLE

The ‘antisymmetric’ programme: theoretical and typological implications¹

GUGLIELMO CINQUE

Seminario di Linguistica, Università di Venezia

(Received 15 January 1996)

Richard S. Kayne, *The antisymmetry of syntax*. (Linguistic Inquiry Monograph 25.) Cambridge, MA: MIT Press, 1994. Pp. xv + 195.

I. INTRODUCTION

In more mature fields of inquiry, the existence of anomalies is no reason to reject a theory which provides non-trivial explanations for a significant set of relevant phenomena. It may, however, decree the superiority of one theory over another when one but not the other is able to explain the anomalies away (while retaining an explanation for the same basic set of phenomena).²

A well-known anomaly of all theories of syntax in the Sixties, the Seventies and the Eighties was the existence of various (unexpected) left-right asymmetries in the syntax of natural languages, both within single languages, and cross-linguistically.

For example, it was known since the mid-Sixties that while movement to the left (in a ‘right branching’ language like English) could apply over an unbounded domain, apparent movement to the right was ‘upward bounded’ (Ross 1967: 307).

More puzzling still was the subsequent observation that in what were then analysed as the mirror-image left branching languages of the OV type (see Chomsky (1964: 123, fn. 9)), no mirror-image unbounded movement to the right was attested either (see Bach (1971: 161), Bresnan (1972: 42 ff.)), despite a few occasional claims to the contrary.³

The various theories proposed, up to the Principles and Parameters theory of the Eighties and the early Nineties, were unable to provide an answer to

[1] I thank Paola Beninca, Richard Kayne, Ian Roberts and Maggie Tallerman for helpful comments.

[2] For the notion of anomaly and its role in the change of scientific paradigms, see Kuhn (1962: ch. 6).

[3] See Satyanarayana & Subbarao (1973), Kaufman (1974), Colarusso (1979).

these (as well as other) anomalies, due to their excessively unconstrained character.

In Kayne's *The antisymmetry of syntax* (henceforth AS), a drastic tightening of the theory is proposed, which, among other things, appears to be able to derive the 'anomaly' of the general left-right asymmetry of natural languages.⁴ This tightening involves a particular view of the mapping between hierarchical structure and linear order, which – Kayne suggests – used to be conceived of in an overly permissive way, with precedence entirely dissociated from hierarchical relations such as c-command. Kayne proposes interlocking the two, in such a way that the fundamental antisymmetry of linear order (not (A > B, and B > A)) be rigidly matched by a corresponding antisymmetry in the underlying hierarchical structure: namely, ASYMMETRIC C-COMMAND (not (A c-commands B and B c-commands A)). The idea is that, given two nonterminals, X and Y, and the terminals they dominate, x and y, 'if X asymmetrically c-commands Y, x precedes y' (33).⁵

The fact that all terminals must be ordered in a (consistent) precedence relation, and the assumption that asymmetric c-command between nonterminals maps to linear precedence between the respective terminals (formulated by Kayne in a 'Linear Correspondence Axiom' (LCA – see pp. 5 f.), have a number of non-trivial theoretical and empirical consequences, first and foremost, the exclusion of many hierarchical configurations which are too symmetric, and which thus fail to determine a unique precedence relation between their terminals.

For example, the case of a phrase (K) exhaustively dominating two phrases (M and P) is ruled out for this reason:

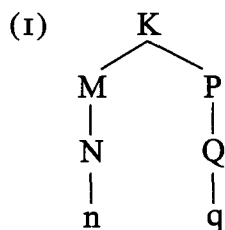

The nonterminal M asymmetrically c-commands the nonterminal Q, thus implying that M's terminal, *n*, PRECEDES Q's terminal, *q*. On the other hand, the nonterminal P also asymmetrically c-commands the nonterminal N, thus

[4] This follows Kayne's (1984) earlier attempt to constrain the theory of phrase structure by excluding all but binary branching configurations, with the effect of reducing the possibilities made available by UG.

[5] Strictly speaking, asymmetric c-command could translate into precedence or subsequence, but Kayne shows that it is precedence rather subsequence, due to the fundamental asymmetry of time (see his discussion in section 4.3).

implying that P's terminal, *q*, PRECEDES N's terminal, *n*: a contradictory result.

A phrase (K) dominating a head (N) and another phrase (P) instead permits assigning a non-contradictory precedence relation among the respective terminals (as N alone asymmetrically c-commands Q):

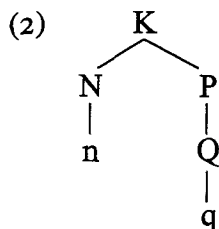

This has the effect of deriving part of the basic tenet of X-bar theory that all phrases be headed (be endocentric).

2. DERIVING X-BAR THEORY

Kayne's LCA, in fact, derives most stipulated properties of X-bar theory: in addition to (3a), just mentioned, we have (3b-d):

- (3) (a) There can be no phrase dominating two (or more) phrases. (11)
- (b) There cannot be more than one head per phrase. (8)
- (c) A head cannot take another head as complement. (8)
- (d) A head cannot have more than one complement. (136, fn. 28)⁶

Moreover, the adoption of a particular definition of c-command, exclusively referring to categories rather than segments,⁷ achieves the interesting related properties in (4):

- (4) (a) A specifier is an adjunct. (17)
- (b) There can at most be one adjunct/specifier per phrase. (22)

[6] That a head cannot be a specifier is also derived, albeit via a further assumption ('that the highest element of a chain of heads must have a specifier' (31)). If a head, in order to be licensed, needs to project (and discharge its theta-role(s)), it follows that the source of a head in specifier position must be a lower head position. But then the possibility arises of excluding its moving to a specifier position as a violation of Relativized Minimality (Rizzi, 1990; or 'Shortest Movement' – Chomsky 1995). A closer potential landing site (the head of the phrase it adjoins to) is skipped (this still does not prevent a head from becoming its own specifier).

[7] Namely: 'X c-commands Y iff *x and Y are categories* and X excludes [footnote omitted, G. C.] Y and every category that dominates X dominates Y' (16), where, as in Chomsky (1986: 9), 'X excludes Y if no segment of X dominates Y'.

- (c) At most one head can adjoin to another head. (20 f.)
- (d) No non-head can adjoin to a head. (19)
- (e) Adjuncts/specifiers c-command out of the category they are adjoined to. (18)
- (f) An X' (the sister node of a specifier) cannot be moved. (17)

Note that the identification of adjuncts with specifiers, and the prohibition against more than one adjunct/specifier per phrase, are by no means logically necessary properties of X-bar theory. It could well be that natural languages allow for phrases with multiple specifiers, and multiple adjuncts (Chomsky 1995). In fact, a definition of C-COMMAND slightly different from the one assumed in AS would seem to achieve just that, while retaining most other features of Kayne's system.⁸

It is however clear that the one-specifier/one-head theory is more restrictive (in that it gives a principled limit to the number of adjuncts/specifiers available), and hence should be preferred, it seems, if empirically adequate.

In fact, were no such limit imposed, some desirable empirical consequences of Kayne's system would seemingly be lost. Consider one example discussed in AS (54).

If C⁰ is the highest clausal head (necessarily preceding its complement), languages with final complementizers must be analysed as requiring movement of the IP complement of C⁰ to its left, plausibly into Spec,CP. (This, incidentally, accords well with the general OV character of such languages, where the complement of V can also be taken to move leftward over V.) If so, Spec,CP is no longer available for a *wh*-phrase to move to: a

[8] Compare the AS definition of c-command given in the previous footnote with (i) below, where *segment* replaces the second mention of *category*:

- (i) X c-commands Y iff X and Y are categories and X excludes Y and every SEGMENT that dominates X dominates Y.

This change ensures that the second (higher) adjunct/specifier asymmetrically c-commands the first adjunct/specifier since every segment that dominates X in (ii) dominates Y, but not viceversa:

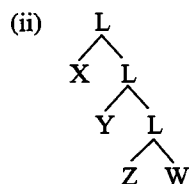

This alternative however loses property (4e) (see AS: 133 f., fn. 3), an empirically undesirable move.

desirable consequence, as it was observed in Bach (1971: 161)⁹ that interrogative *wh*-movement is generally absent from SOV languages.¹⁰

A system which systematically allows for multiple specifiers derives instead no such consequence, as more landing sites could in principle be available, one for the IP complement of C⁰, and one for *wh*-phrases.¹¹

Besides the theoretical advantage of deriving (hence explaining) the basic properties of X-bar theory, the AS system has the important theoretical consequence of introducing severe restrictions on the possible phrase structures (and derivations) admitted by UG.

3. A UNIVERSAL (SPECIFIER > HEAD > COMPLEMENT) ORDER AND LEFT/RIGHT ASYMMETRIES

If asymmetric c-command maps to linear precedence, as noted, adjuncts/specifiers, which asymmetrically c-command their heads, necessarily precede them; analogously, heads which asymmetrically c-command their complements, necessarily precede them; and this imposes a rigid specifier > head > complement order. A complement which is to the left of its head cannot be in 'complement position', but must have raised to a position (adjunct/specifier) which asymmetrically c-commands (its trace and) the head. Analogously, a head which is to the left of its specifier must have raised to a head position asymmetrically c-commanding (its trace) and the specifier.

This clearly requires a radical rethinking of many traditional analyses and assumptions (a typical feature of a change of paradigm). OV languages can no longer be seen as mirror images of VO languages, but rather as VO languages whose objects have raised across their heads. Moreover, all apparent movements of X to the right of Y must be rethought of as movement of Y to the left of X, or in terms of independent 'base generation' of X to the right of Y.

Kayne shows that in most cases independent considerations are against a rightward movement analysis of Right Node Raising (67 f.), Heavy NP shift

[9] Also see Greenberg's (1966) Universal 12:

'If a language has dominant order VSO in declarative sentences, it always puts interrogative words or phrases first in interrogative word questions; if it has dominant order SOV in declarative sentences, there is never such an invariant rule'.

[10] As Kayne himself notes (142, fn. 20), the prediction is actually more delicate in a theory allowing for more than one CP, and more work is clearly needed to sharpen the contours of the 'split COMP' space (see Rizzi 1995). But it seems that the tendency is robust enough to warrant the conclusion he draws.

[11] An empirical argument, apparently supporting the SINGLE SPECIFIER theory over the MULTIPLE SPECIFIER theory, is presented in Cinque (forthcoming), and is essentially based on evidence from Romance for the existence of a head position in between any two specifiers.

(71 ff.), Subject Inversion (or Postposing) in Romance (77 f.), Right Dislocation (78 ff.), Relative Clause (and PP) Extraposition (117 ff.), Result and Comparative Clause Extraposition (126 ff.), and in favour of either an independent base generation or stranding of the (apparently) moved constituent in a c-commanded position.

As anticipated above, a general consequence of the AS system is a principled account of many left/right asymmetries in natural languages. The general 'upward boundedness' of all (apparent) movements to the right, which has to be stipulated in theories that allow such movements, follows if no adjunction (hence no movement) TO A C-COMMANDING POSITION TO THE RIGHT is permitted.¹²

From the same ban against rightward movement/adjunction also follows the mentioned absence of *wh*-movements to final position in OV languages (as opposed to leftward *wh*-movements to initial position in VO languages).

It is impressive how many standard analyses have to be reconsidered and reanalysed in the light of the AS system, with illuminating results.

In addition to the consequences already mentioned, the AS system forces the adoption of a 'promotion' analysis of relative clauses (where the relative CP is a sister of D⁰ and the relative clause 'head' raises from inside the relative CP to Spec, CP (86 ff.)), and opens up alternative analyses for possessive phrases (85, 101 ff.) and adjective phrases (97 ff.), within the DP. As Kayne succinctly and aptly puts it, if one adopts the AS system, one has 'the all too infrequent pleasure of seeing the theory choose the analysis' (132), with obvious desirable repercussions for the rational reconstruction of language acquisition.

Any attempt to discuss the many language specific and typological consequences of the AS system is clearly out of the question here. In what follows, I will limit myself to four points: first, to discussing one additional case of left/right asymmetry which appears to find an interesting account in the AS system (section 4); secondly, to pointing out certain areas where a further tightening of the AS system may be possible (section 5); thirdly, to discussing the AS analysis of clitics, for which I will suggest an alternative compatible with the antisymmetric programme (section 6), and finally to suggesting a possible extension of the LCA to phonology (section 7).

4. AN ADDITIONAL LEFT/RIGHT ASYMMETRY

One more left/right asymmetry which the AS system appears to accommodate naturally is Greenberg's (1966: 87) Universal 20:

[12] Movement to the right to a C-COMMANDED position (lowering) is also excluded, by the general Proper Binding Condition (Fiengo 1977), whether this is a primitive, or derives from some other abstract principle(s).

'When any or all of the items (demonstrative, numeral, and descriptive adjective) precede the noun, they are always found in that order. If they follow, the order is either the same or its exact opposite.'

The left/right asymmetry consists in the fact that while to the right of the N both the order Dem(onstrative) Num(eral) A(djective), and its mirror-image, A Num Dem, are possible, to the left of the N only the order Dem Num A is attested.

How can we make sense of this asymmetry? A clue comes from the finer grained study of Hawkins' (1983).¹³ Hawkins' points out that in prepositional languages 'if the demonstrative determiner follows the noun, the adjective follows the noun; i.e. Prep \supset (NDem \supset NA)' (71). In other words, we have prepositional languages displaying the orders in (5), but no prepositional language displaying the order in (6) (also see Greenberg 1966: 86, table 6):

- (5) (a) NDem & NA (Swahili, Fulani, Bahasa Indonesian, ...)
- (b) DemN & NA (Maori, Baure, Douala, Tunen, ...)
- (c) DemN & AN (Greek, Maya, Norwegian, ...)
- (6) *NDem & AN

Likewise, considering the relative order of numerals and adjectives, Hawkins points out that in prepositional languages 'if the numeral follows the noun, the adjective follows the noun; i.e. Prep \supset (NNum \supset NA)' (72). In other words, there are prepositional languages displaying one of the orders in (7), but none displaying the order in (8):

- (7) (a) NNum, & NA (Swahili, Douala, Tunen, ...)
- (b) NumN & NA (Maori, Baure, Bahasa Indonesian, ...)
- (c) NumN & AN (Greek, Maya, Norwegian, ...)
- (8) *NNum & AN

The pattern of attested (and unattested) word orders in (5) through (8), and Hawkins' implicational universals based on them (Prep \supset (NDem \supset NA) and Prep \supset (NNum \supset NA)) appear to follow from the two simple assumptions in (9):

- (9) (a) The base structure is:

... [XP [XP X [YP Dem [YP Y [WP Num [WP W [ZP Adj [ZP Z [NP N]]]]]]]]]]

[13] Hawkins' study is based on an expanded sample, with data from over 150 languages (compared with Greenberg's 30 language sample) for the word orders of demonstrative, numeral, adjective and noun (see Hawkins 1983: 9 and ch. 8).

i.e. with demonstratives in a Spec higher than the one containing numerals, which in turn is higher than the Spec containing adjectives.¹⁴

- (b) N either remains in situ or raises to one of the higher (functional) heads (W in Maori – see (5b), (7b); Y in Douala – see (5b), (7a); X in Swahili – see (5a), (7a)).¹⁵

This implies that whenever N precedes Num (is in Y or higher) it will a fortiori precede the adjective; whence the theoretical impossibility of (prepositional) languages displaying the word order correlations in (8). Similarly, whenever N precedes Dem (is in X, or higher), it will a fortiori precede the adjective; whence the theoretical impossibility of the word order correlation in (6) above.¹⁶

Consider now postpositional languages. As Hawkins (1983: 81–82) notes, '[i]nstead of the expected mirror-image implication, $\text{Post} \supset (\text{DemN} \supset \text{AN})$,

-
- [14] Evidence for locating demonstratives and adjectives in specifier positions within the extended projection of the N is discussed in Giusti (1992, 1993) and Cinque (1994), respectively (also see Brugè 1995). Additional evidence for Giusti's idea that demonstratives are in specifier position as opposed to determiners (articles) – which are in head position within the extended projection of the N – appears to come from certain typological findings of Dryer's. While, as Dryer (1989) notes, article-N order correlates with V-O order (as one would expect if the article is a head taking a projection of the N as its complement), no such correlation exists for the order demonstrative-N (Dryer 1992: 96, 120 ff.), as is also the case with other nominal modifier-head pairs (Adj-N, Numeral-N, Intensifier-Adj, etc. – Dryer (1988, 1992: 95, 97, 118 ff.).
- [15] For an analogous proposal concerning the position of the N with respect to different classes of adjectives in Romance vs. Germanic, see Cinque (1994).
- [16] On the basis of (9), we should also expect the existence of prepositional languages with one of the orders in (i), and the non-existence of prepositional languages with the order in (ii):
- (i) (a) NDem & NNum
 - (b) DemN & NNum
 - (c) DemN & NumN
 - (ii) *NDem & NumN

This word order is not explicitly discussed in Hawkins (1983). To judge from Greenberg's (1966) 30 language sample, it would seem to be largely observed (it is in 10 out of the 16 prepositional languages of the sample), although there are some counterexamples (Berber, Hebrew, Welsh, Zapotec), apparently instantiating (ii). These, however, may turn out to be spurious if demonstratives, rather than being base-generated in a Spec to the left of numerals as in (9a), are MOVED there from a lower position, and may/must remain in situ in certain languages. On the basis of Spanish, Brugè (1995), in fact argues that they are generated in a position between the rightmost AdjectiveP and the subject of the NP (compare *El libro viejo este suyo de syntaxis* 'the book old this his of syntax'), apparently the same position hosting *ci* of *ce...ci* 'this here' in French (*Ce livre rouge-ci de Marie sur la linguistique* 'this book red here of Marie on linguistics'), and *là* of *quello là* 'that there', in Italian.

Interestingly, among the apparently problematic cases in Greenberg's sample, both Welsh and Hebrew have demonstratives only in situ, in this low position within the DP (*Y pump llyfr newydd HYN gan John ar wleidyddiaeth* 'the five books new these of John on politics' = 'these five new books by John on politics' – M. Parry personal communication); and *Shloshet ha-yeladim ha-ktanim HA-ELU* 'Three the-children the-small these' = 'these three small children' – U. Shlonsky and T. Siloni personal communication).

we find that postpositional languages obey the same implicational regularity as prepositional languages: $NDem \supset NA$. Analogously, $NNum$ implies NA . In other words, while there are postpositional languages with the orders (10) and (11), there are none with the orders (12) and (13) (see Hawkins 1983: 81 f.):

- (10) (a) $NDem$ & NA (Selepet, Mojave, Diegueño, ...)
- (b) $DemN$ & NA (Burmese, Kabardian, Warao, ...)
- (c) $DemN$ & AN (Burushaski, Hindi, Japanese, ...)

- (11) (a) $NNum$ & NA (Selepet, Mojave, Kabardian, Warao, ...)
- (b) $NumN$ & NA (Burmese, Hixkaryana, Ubykh, ...)
- (c) $NumN$ & AN (Burushaski, Hindi, Japanese, ...)

- (12) * $NDem$ & AN
- (13) * $NNum$ & AN

If postpositional (OV) languages were 'symmetric' to prepositional (VO) languages, with Spec's on the right and with rightward movement, as illustrated in (14), one would expect that $DemN$ implied AN , thus ruling out the existence of postpositional languages with both $DemN$ and NA . But these are attested (see (10b) above):¹⁷

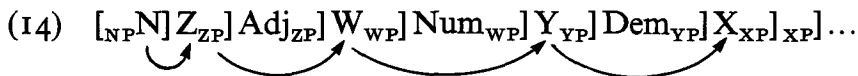

The AS system, in ruling out any such mirror-image structures and derivations, leaves only two general possibilities, beginning from the structure in (9a) (shared with prepositional languages).¹⁸ Either nothing moves, in which case we have the order: $DEM > Num > Adj > N$, as found in, for example, Hindi (see Hawkins (1983: 119); the same order as that yielded by prepositional languages where nothing moves); or we have a number of successive leftward movements of the complements of the functional heads Z, W, Y of (9a) to Spec positions of intermediate (possibly Agreement) XPs, as shown in (15). This gives the $N Adj Num Dem$ order possibility of

[17] In the SYMMETRIC view, we would also expect the existence of postpositional languages with the orders $Adj > N > Num > Dem$ and $Adj > Num > N > Dem$ (with N raised to W and Y of (14), respectively). But none exist, as seen, given the implication holding of postpositional (and prepositional) languages, that $NDem \supset NAdj$ (see Hawkins (1983: 81), already quoted).

[18] Whitman (1981) shows that the case of adjectives occasionally preceding the demonstrative and the numeral in head-final languages does not contradict Greenberg's finding concerning the order of pre- $N Dem Num Adj$, as pre- Dem adjectives can only be interpreted non-restrictively in head-final languages, just like pre- Dem relative clauses (which suggests that pre- Dem adjectives are in fact reduced relatives).

Greenberg's Universal 20 displayed by postpositional OV languages like Selepet (Hawkins 1983: 119):¹⁹

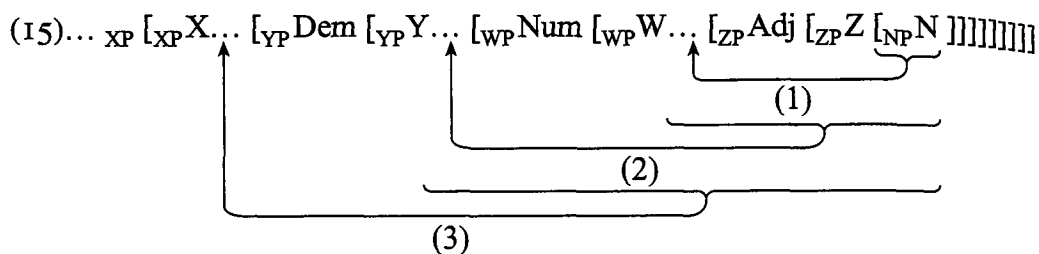

Evidence apparently supporting the derivation shown in (15) is provided by the fact that the intermediate steps of (15) are also attested; namely the orders: Dem N Adj Num, found in such postpositional languages as Kabardian and Warao (Hawkins 1983: 119), derived via the steps (1) and (2) of (15), and the order Dem Num N Adj of such postpositional languages as Burmese, Kokama and Ubykh (Hawkins 1983: 81 f.), which can be taken to be derived via step (1) of (15).²⁰

That it is NP raising to the left of the Adj in the latter postpositional languages (rather than N raising, as in prepositional languages) may be indicated by the fact that in these languages the Genitive (in Spec, NP) precedes the N, whereas in prepositional languages when the adjective follows the N so does the Genitive (see Hawkins 1983: 66). This follows if we have N raising across the Adjective in prepositional languages ((16a)), and NP raising across the Adjective in postpositional languages (16b)):

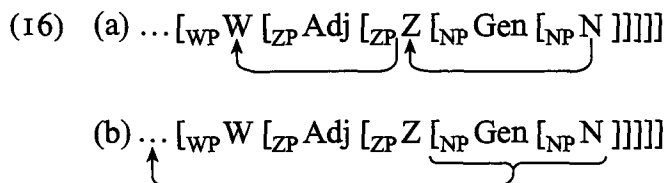

It should be noted that whereas postpositional languages have (successive) leftward XP movements, as seen (and, possibly, no leftward movement of

[19] These (successive) leftward movements of XPs are typical of postpositional (OV) languages. See the AS discussion of agglutination and final complementizers in head-final languages (52 ff.).

[20] It seems that step 2 (and 3) of (15) cannot apply unless step (1) has also applied. Otherwise, the unattested order Adj N Num Dem (see fn. 17) would be derived. The Num > N > Adj > Dem order found in Basque (Hawkins 1983: 119) would seem to be derivable via steps (1) and (3) of (15), without the application of the intermediate step (2), possibly a marked option. The same order in prepositional languages (Welsh, Hebrew and the others cited in Rijkhoff (1990: 27)) should instead be interpreted as seen in fn. 16 above, with the demonstrative occurring in the lower BASE GENERATION position. It remains to be seen whether the exceptions to Hawkins' NDem > NAdj that Dryer (1988: 208) found in his sample are amenable to a similar account. For a case (Aghem), which appears problematic from the present perspective, see Hawkins (1983: 119).

just the N), prepositional languages have N raising, but crucially no leftward XP movements here. If they could move the XP complements of the functional heads W and Y, as illustrated in (17), orders should be possible which are not attested, namely Dem Adj N Num, and Num Adj N Dem:

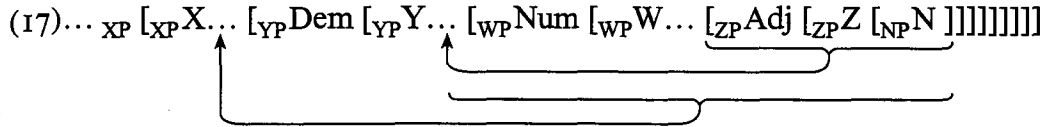

Hawkins (1983: 118) explicitly notes that no such orders are attested in his data.²¹

In sum, in as much as it is able to derive the Dem Num A N order, as well as the N Dem Num A and the N A Num Dem orders, but is unable to derive the unattested A Num Dem N order (among others), the AS system affords a principled explanation of Greenberg's Universal 20 (with its left/right asymmetry), and Hawkins' refinements of it; a remarkable feat.

5. POSSIBLE FURTHER RESTRICTIONS OF THE AS SYSTEM

The system proposed in AS drastically limits, as seen, the possibilities made available by UG. Nonetheless, it is possibly open to still more restrictions. For example the targets of many leftward movements are left open, as is the general architecture of the clause, certainly because determining their status is largely an empirical question that has barely begun to be investigated.

Clearly, the predictions made by the system will be all the more precise as these questions are ultimately settled one way or the other.

If projections were not FUNCTIONALLY SPECIALIZED (and labelled), and were not limited in stock, the derivation of the left/right asymmetry in *wh*-movement discussed above in section 2 would not be straightforward. For example, the possibility must be excluded that a head be freely created, to host a *wh*-phrase in its specifier, above the CP in whose specifier IP has raised. If the structure of the clause is fixed once and for all, this possibility may be excluded as a matter of principle.

[21] Although they are allowed by Greenberg's (1966) 'any or all' clause in his Universal 20 – see Hawkins (1983: 117 ff.) for discussion. Dem > Num > N > Adj is attested (in Romance), but as a function of the movement of the N alone, not of NP, as shown by the impossibility of Dem > Num > [Gen N] > Adj.

That postpositional, but no prepositional, languages CAN move XP complements of functional heads leftward (successively) seems to be at the basis of two more left/right asymmetries between the two types of languages – see Hawkins (1988), Dryer (1992: 86, 102): (i) while, in postpositional languages, complementizers may be either to the left of the clause (initial), or to its right (final), in prepositional languages, they are invariably to its left (initial) (pace Chinese, which has many features of postpositional languages, such as relative clause-N, Standard-Adj, etc.); (ii) while postpositional languages have either relative clauses preceding the N, or following it, prepositional languages only have relative clauses following the N (again pace Chinese).

The existence of more than one CP does not by itself jeopardize the account of the left/right asymmetry of *wh*-movement, at least if the various CPs are functionally specialized, and, for example, IP were to raise to the Spec of a CP higher than the WH CP.²² Once again, this ultimately reduces to an empirical issue (within a more general matter of principle). The same is clearly desirable for the 'space' below C.²³

I will now turn to another apparent consequence of the AS system discussed by Kayne, suggesting a possible alternative which is still compatible with the antisymmetric spirit.

6. THE ADJUNCTION SITE OF CLITICS (IN ROMANCE)

Differently from Kayne (1975, ch. 2), AS takes clitics not to adjoin directly to verbs; a conclusion based on the following *reductio ad absurdum*. If the LCA extends to subword structure, a verb of the form stem + thematic vowel + suffix must have the thematic vowel adjoined to the suffix, the head of the word, and the stem adjoined to the thematic vowel:

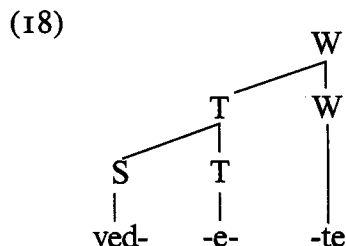

A clitic could not adjoin to the nonterminal dominating the suffix nor to that dominating the thematic vowel as it would qualify as a second adjunct. It could only adjoin to the stem. By the same token, however, if the stem were preceded by a prefix (which would have to be adjoined to the stem) the clitic could only be adjoined to the prefix, not to the stem; thus giving an apparently unnatural result.

So, either the LCA does not extend to subword structure, or clitics adjoin to an (empty) functional head higher than the verb.²⁴

[22] In this case, there would be no landing site for the *wh*-phrase higher than the fronted IP, nor could the *wh*-phrase move to the WH COMP leaving its trace unbound within the IP moved higher than the *wh*-phrase.

[23] For a specific proposal in this direction, see Cinque (forthcoming). At first sight, the MULTIPLE SPECIFIER and the ONE HEAD/ONE SPECIFIER theories would seem to be equivalent, at least if one were to introduce a functional specialization, and a rigid relative order of the multiple specifiers. But the two theories can be empirically distinguished on other counts, and the facts seem to support the one head/one specifier theory (see Cinque (forthcoming) for discussion).

[24] I am restricting attention to proclitics. For enclitics, see AS: 139, fn. 19.

Since they clearly adjoin to higher heads in certain cases (for example, *En fort bien parler* 'of-it strong well to-speak' – Kayne (1991: 654 fn. 18)), taking them to always do so allows the LCA to hold of subword structure: a welcome result because of its restrictiveness.

This implies, then, that in a French subject clitic – verb inversion like (19) the verb is not in C, as there must be a distinct higher head, between Spec, C and the verb, to which the (object) clitic *la* is adjoined:

- (19) Depuis quand *la* connais-tu?
 since when her know you
 'Since when do you know her?'

If it may have the desirable effect of giving an account for complex inversion (*Quand Jean est-il arrivé?* 'When has Jean arrived?'), and the impossibility of **Est Jean à Paris?* 'Is Jean in Paris?' in French (see AS, p. 44), this assumption does not extend as straightforwardly to other Romance constructions, where a clitic still precedes a verb which has arguably raised to C. For example, in Italian, the construction in (20), which displays the order complementizer + subject + subjunctive verb, has an alternative where the subjunctive verb precedes the subject and no complementizer can be present, thus suggesting that the V has raised to C. See (20) and (21):²⁵

- (20) **(Che) tu sia convinto di questo, o no, fa poca differenza.*
 'Whether (lit. 'that') you are convinced of this, or not, makes little difference.'
 (21) *(*Che) sia tu convinto di questo, o no, fa poca differenza.*
 'Whether you are (lit. 'Be you') convinced of this, or not, makes little difference.'

Crucially, if a clitic is present it must precede the verb (in C):

- (22) *Ne sia tu convinto, o no, fa poca differenza.*
 'Whether you are convinced of this, or not, makes little difference.'

[25] An argument of this type for V to C raising is discussed in relation to a similar construction in Rizzi (1982: 83 f.). Here we have additional evidence that it is the verb that has raised over the subject (to C⁰), as the 2nd person singular of the present subjunctive can not be a null personal pronominal, and can be a null expletive in construction with an inverted subject only marginally. See:

- (i) (a) Credono che (io)/*(tu)/(lui) mi/ti/si sia sbagliato.
 they-think that (I)/(you)/(he) was/were/was mistaken
 (b) Credono che mi/ti/si sia sbagliato io/??tu/lui.
 they-think that was/were/was mistaken I/you/he

The marginality of the variant of (ib) with *tu* thus contrasts with the perfect status (at a high stylistic level) of (21).

As a matter of fact, French presents a comparable construction:

- (23) (a) Peut-être qu'il l'a reçu.
 maybe that he it has received
 'Maybe he has received it.'
 (b) Peut-être (*que) l'a-t-il reçu.
 maybe (*that) it has he received
 'Maybe he has received it.'

In both cases, the order clitic > verb > subject follows automatically if the clitic is indeed adjoined to the verb in I, before its movement to C across the subject.

In the AS system, there must be a higher C to which the clitic independently moves, and a separate principle that demands that clitics always attach to a head preceding the position of the finite verb, whatever that is, I or C. Note, however, that in the latter analysis one could in principle expect some element to intervene between the clitic and the verb even in the COMP space (as it does in the IP space, as seen above). But no such case (as **Le peut-être a-t-il reçu* 'It maybe has he received') is attested, as far as we know, in any regional, stylistic, or ancient variety of French.

Suppose we were to conclude then that clitics can adjoin to a verb (when this has raised to the relevant functional category).²⁶ Would that exclude an extension of the LCA to subword structure? Not necessarily. It seems possible to retain the extension of the LCA to subword structure while at the same time permitting clitics to adjoin to verbs; namely by having the LCA apply in the subword (morphological) component with results that are 'invisible' to the syntactic component.

This amounts to saying that a verb, even if morphologically complex ([re[at[test[s]]]]) is syntactically simplex; merely a V.

Under a CHECKING BY RAISING theory (Chomsky 1995; AS 140: fn. 10), this conclusion is in fact almost forced, it seems. If words come fully inflected from the lexicon, should the SYNTACTIC category of the word be determined by its rightmost morphological element, we would never have a VP, but, directly TenseP (in a case like *reattested*); or NumberP, in a case like *reattests*, if *-s* codes number (Kayne 1989): not a fully satisfactory result.

Moreover, if the LCA were to extend to phonology, as I tentatively put forth in the next section, there would be one more reason for separating the application of the LCA to subword (morphological) and above word (syntactic) structure. For, in that case, I think, we would have little doubt about the essential irrelevance of any internal phonological structure of the

[26] Under this view, the clitic, which I take to move as a head in the last step of its movement, after moving within a DP (see AS: 61), either adjoins to the relevant F⁰, if this is empty, or to the V which has adjoined to F⁰, in either case complying with the LCA.

word to syntax. By the same token, our view of morphological subword structure vis-à-vis syntactic structure should probably be no different.

7. THE LCA IN PHONOLOGY

As seen, the LCA implies that the antisymmetry of linear order reflects a comparable antisymmetry in underlying hierarchical structure. In AS, Kayne considers the consequences of this idea for syntax and morphology. Suppose we took it to hold of phonology as well. That would mean that the linear order of segments should reflect a comparable antisymmetric underlying hierarchical structure. As a matter of fact, such structure is (virtually) already given if one thinks of syllable structure, which a rich tradition views in an X-bar format, with the ONSET as the Specifier of a head (the NUCLEUS), which is taken to form a constituent (the RHYME) together with a complement (the CODA): [_{syllable} onset [_{rhyme} nucleus coda]], where syllable = NucleusP, or, for simplicity, V(owel)P (see Kenstowicz (1994; chs. 6, 8) and references cited there. In this view, the organization of segments into syllables would be a consequence of the antisymmetric nature of language.

Needless to say, a proper extension of the LCA to the syllable plane requires a number of non-trivial modifications of standard assumptions, whose phonological significance would have to be ascertained. That cannot be done here. Here I will limit myself to some of the implications that ensue from such an extension.

For example, to give a total linear order of all the Cs and Vs, the representation of a plurisyllabic word would have to look something like the tree in (24):

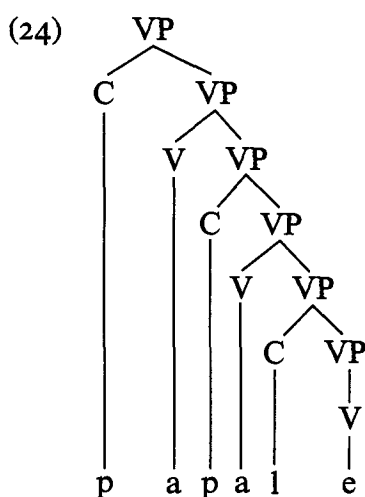

Although CV is the unmarked syllable (in some languages, the only type of syllable), departures from it, involving complex onsets and codas, are very common. For onsets, this could imply replacing C with a NONTERMINAL

REVIEW ARTICLE

structure consisting of up to 2 (or 3) VPs, while onsets (of overt nucleus VPs) do not by themselves).

Other adjustments would be necessary if we were to follow up this extension, which, needless to say, at this stage, can only be a promissory note.

8. CONCLUSION

Even if I have decided to focus here on a very limited number of consequences of Kayne's work, I hope I have at least given a sense of the extremely far-reaching implications of his overall theoretical programme. If one were not to feel uneasy when comparing the theory of syntax with the theories of more mature sciences, one could picture Kayne's theory as our closest approximation to a revolution, which will be followed by a period of normal science trying out all of its consequences and implications (until the next revolution).

REFERENCES

- Bach, E. (1971). Questions. *Linguistic Inquiry* 2. 153-166.
- Bresnan, J. (1972). *Theory of complementation in English syntax*. Ph. D. dissertation, MIT.
- Brugè, L. (1995). Il movimento del dimostrativo in spagnolo. Ms., Università di Venezia e Padova.
- Charette, M. (1991). *Conditions on phonological government*. Cambridge: Cambridge University Press.
- Chomsky, N. (1964). On the notion 'rule of grammar'. In Fodor, J. & Katz, J. (eds.) *The structure of language: readings in the philosophy of language*. Englewood Cliffs, NJ: Prentice Hall. 119-136.
- Chomsky, N. (1986). *Barriers*. Cambridge, MA: MIT Press.
- Chomsky, N. (1995). *The minimalist program*. Cambridge, MA: MIT Press.
- Cinque, G. (1994). On the evidence for partial N-movement in the romance DP. In Cinque, G., Koster, J., Pollock, J.-Y., Rizzi, L. & Zanuttini, R. (eds.) *Paths towards universal grammar. Studies in honor of Richard S. Kayne*. Washington: Georgetown University Press. 85-110.
- Cinque, G. (forthcoming). *Adverbs and the universal hierarchy of functional projections*. Oxford: Oxford University Press.
- Colarusso, J. (1979). Rightward movement, question formation and the nature of transformational processes: the Circassian case. *Papere zur Linguistik* 21. 27-73.
- Dryer, M. S. (1988). Object-verb order and adjective-noun order: dispelling a myth. *Lingua* 74. 185-217.
- Dryer, M. S. (1989). Article-noun order, *Papers from the 25th regional meeting of the Chicago Linguistic Society*. Chicago: Chicago Linguistic Society. 83-97.
- Dryer, M. S. (1992). The Greenbergian word order correlations. *Language* 68. 81-138.
- Fiengo, R. (1977). On trace theory. *Linguistic Inquiry* 8. 35-61.
- Giusti, G. (1992). Heads and modifiers among determiners: evidence from Romanian and German. *University of Venice Working Papers in Linguistics* 3. CLI. (Published in Cinque, G. & Giusti, G. (eds.) (1995). *Advances in Roumanian linguistics*. Amsterdam: Benjamins. 103-125.)
- Giusti, G. (1993). *La sintassi dei determinanti*. Padova: Unipress.
- Greenberg, J. (1966). Some universals of grammar with particular reference to the order of meaningful elements. In Greenberg, J. (ed.) *Universals of language*. (2nd edn.) Cambridge, MA: MIT Press. 73-113.
- Hawkins, J. A. (1983). *Word order universals*. New York: Academic Press.
- Hawkins, J. A. (1988). On explaining some left-right asymmetries in syntactic and morphological universals. In Hammond, M., Moravcsik, E., Wirth, J. (eds.) *Studies in syntactic typology*. Amsterdam: Benjamins. 321-357.

JOURNAL OF LINGUISTICS

- Kaufman, E. S. (1974). Navajo spatial enclitics: A case for unbounded rightward movement. *Linguistic Inquiry* 5. 507-533.
- Kaye, J. (1990). 'Coda' licensing. *Phonology* 7. 301-330.
- Kaye, J., Lowenstamm, J. & Vergnaud, J.-R. (1990). Constituent structure and government in phonology. *Phonology* 7. 192-231.
- Kayne, R. S. (1975). *French syntax*. Cambridge, MA: MIT Press.
- Kayne, R. S. (1984). *Connectedness and Binary Branching*. Dordrecht: Foris.
- Kayne, R. S. (1989). Notes on English agreement. *CIEFL Bulletin* 1. 41-67.
- Kayne, R. S. (1991). Romance clitics, verb movement and PRO. *Linguistic Inquiry* 22. 647-686.
- Kenstowicz, M. (1994). *Phonology in generative grammar*. Oxford: Blackwell.
- Kuhn, T. S. (1962). *The structure of scientific revolutions*. Chicago: Chicago University Press.
- Rijkhoff, K. (1990). Explaining word order in the noun phrase. *Linguistics* 28. 5-42.
- Rizzi, L. (1982). *Issues in Italian syntax*. Dordrecht: Foris.
- Rizzi, L. (1990). *Relativized minimality*. Cambridge, MA: MIT Press.
- Rizzi, L. (1995). The fine structure of the left periphery. MS., Université de Genève.
- Ross, J. R. (1967). *Constraints on variables in syntax*. Ph.D. dissertation, MIT.
- Satyanarayana, P. & Subbarao, K. V. (1973). Are rightward movement rules upward bounded? *Studies in the Linguistic Sciences* 3.1. 182-192.
- Whitman, J. (1981). The internal structure of NP in verb final languages. *Papers from the 17th Regional Meeting of the Chicago Linguistic Society*, Chicago: Chicago Linguistic Society. 411-418.

*Author's address: Seminario di Linguistica,
Università di Venezia,
S. Marco 3417,
30124 Venezia,
Italia.
E-mail: cinque@unive.it*